

i-PAN T10 Baseboard

Documentation version 1.1

This document applies to i-PAN T10 V1R2.

Introduction

The i-PAN T10 Baseboard is designed for a direct installation on a 10.1" capacitive touch display. It features most peripherals needed by today's industrial panel-applications and because of that is an ideal basis for customized flat panel PC solutions.

It is sold in combination with a 10.1" display and different CPU-modules and housing options.

Housing options range from simple (glued to back of the display), open metal mounting frame and to a complete closed metal housing. It is designed to be a low-cost solution of the i-PAN XT-Pro 10 panel.

Typical a Trizeps VII SOM with NXP i.MX 6 processor is used as CPU-module. It supports Microsoft Windows Embedded Compact 7 or 2013, Linux and Android OS.

There are iMod flex-cable-connectors and solder-pads to extend the board functionality and connect to Keith&Koep iMod-Adapters or customers peripherals.



Figure 1: i-PAN T10 Baseboard V1R1 assembled on 10.1" touch display with cover lens

Block Diagram

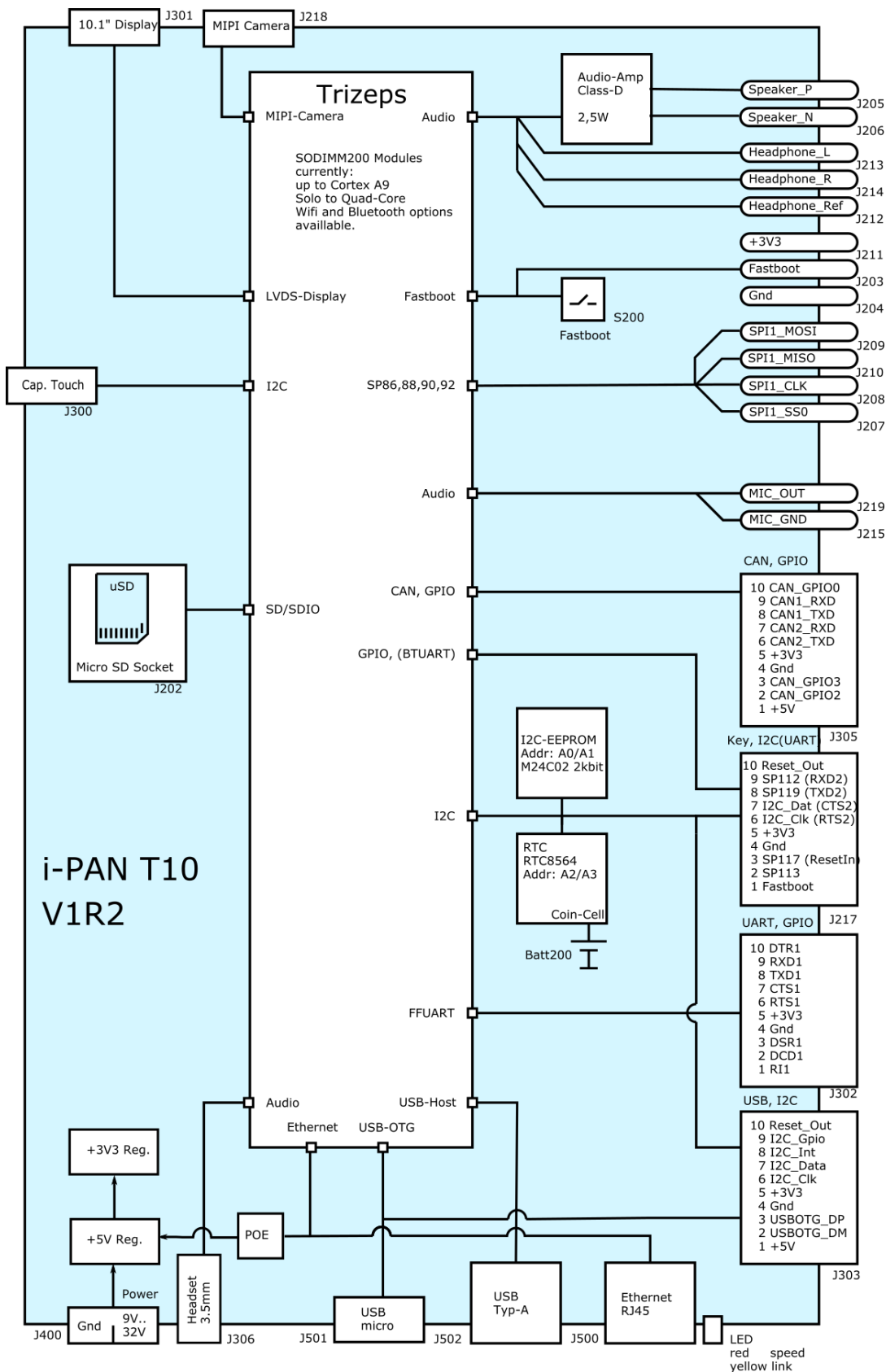

Figure 2: Simplified Block Diagram of i-PAN T10 Baseboard V1R2

1. Connector positions

Interfaces and connectors of i-PAN T10 Baseboard.

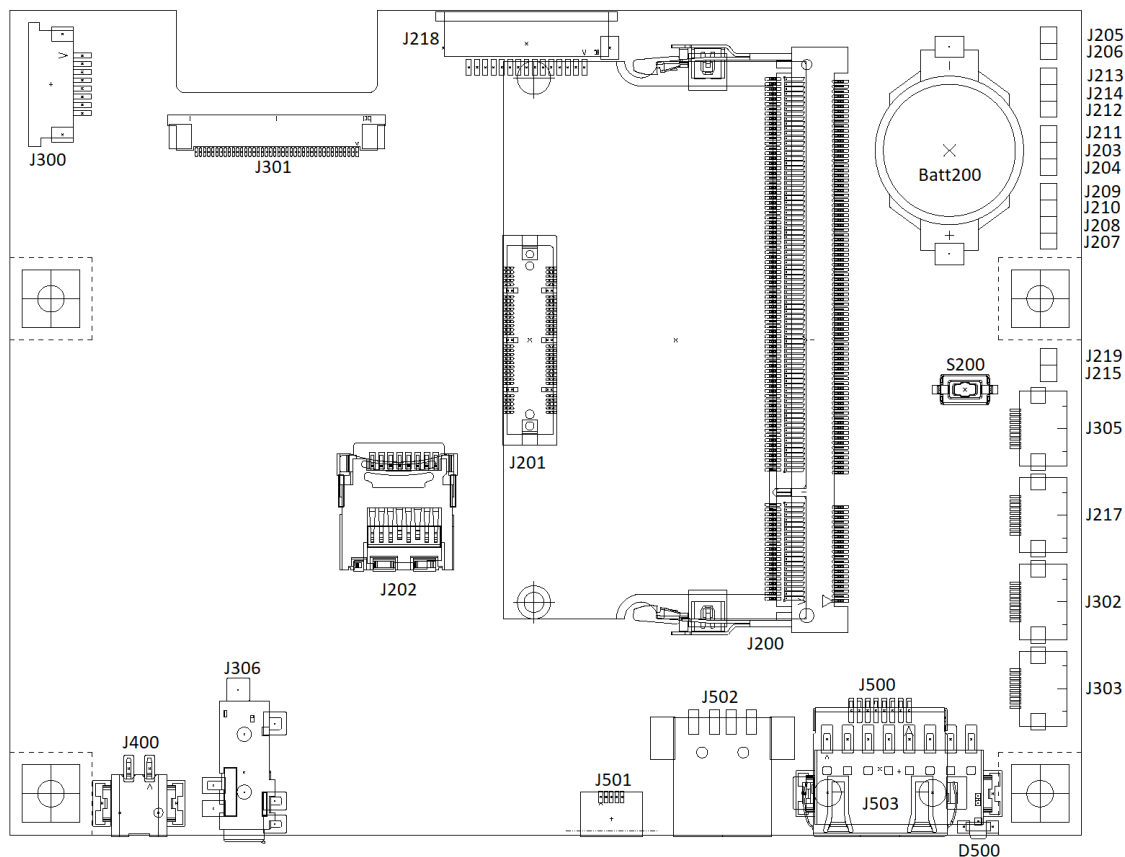

Figure 3: Connectors of i-PAN T10 Baseboard

Connectors:

J200: Trizeps VII SODIMM connector
 J201: Trizeps VII High Speed connector
 J202: μ SD-Card connector
 J217: iMod Button/I2C or UART connector
 J218: Raspberry Pi compatible camera connector
 J300: Touch connector
 J301: Display connector
 J302: iMod UART connector
 J303: iMod USB/I2C connector
 J305: iMod CAN connector
 J306: Headset 3.5 Audio Jack (CTIA)
 J400: Power connector
 J500: Ethernet connector
 J501: μ USB connector
 J502: USB A connector
 J503: PCB terminal block for Ethernet (opt.)

Soldering Pads:

J203: FASTBOOT
 J204: GND
 J205: SPEAKER_P
 J206: SPEAKER_N
 J207: SPI1_SS0
 J208: SPI1_SCLK
 J209: SPI1_MOSI
 J210: SPI1_MISO
 J211: +3V3
 J212: HEADPHONE_GND
 J213: HEADPHONE_L
 J214: HEADPHONE_R
 J215: MIC_OUT
 J219: MIC_GND

Miscellaneous:

BATT200: Battery Connector (CR1632)
 S200: Fastboot button

LED:

D500: DUO LED (Link and Activity)

2. User Connectors

J400: Power connector

Pin	Signal
1	VIN (+9V up to +24V)
2	GND

Connector:

PTSM 0,5/2-HH-2,5-SMD by Phoenix Contact (1778764)

Mating Connector:

PTSM 0,5/2-P-2,5 by Phoenix Contact (1778832)

PTSM 0,5/2-PL-2,5 by Phoenix Contact (1709457) (incl. locking)

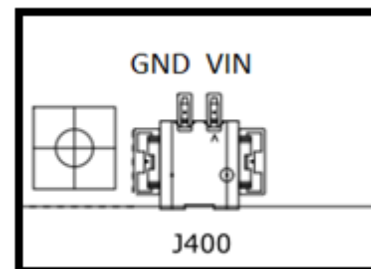

The panel can be either powered by this connector or optional through POE (Power-Over-Ethernet, J500/J503).

Voltage polarity protection is achieved through a diode.
A Nanofuse (near to J400) is used for current protection.

There is an option to mount a Wago 231-532/001-000 instead of the Phoenix PTSM connector.

J306: Headset 3.5mm Audio Jack (CTIA)

The 3.5mm audio-jack is using the commonly used CTIA pinning, so that a standard headphone or headset can be attached to the panel.

The signals are shared with the solder pads J213 (Headphone_L), J214 (Headphone_R), J212 (Headphone_Gnd) and J215 (Mic).

Headphone_L and Headphone_R of this connector are also connected to an internal audio-amplifier, which outputs to the speaker solder pads J205/J206.

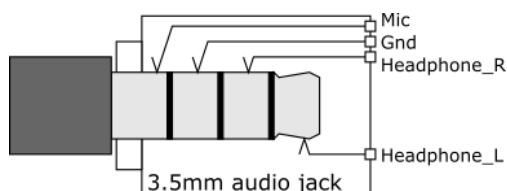

Connector: SJ43514-SMT by Kycon

J501: µUSB connector

Connector: SD-47346-001 by Molex

The USB2.0 Micro-USB connector is routed to USB-OTG port of the Trizeps module.
Function depends on the placed Trizeps module and operating system.

This interface may be used as USB-Slave, USB-Host or real USB-OTG port.

Note that the USB-OTG port is also connected to the iMod USB/I2C connector J303.
Only one of both connectors can be used at the same time!

J502: USB A connector

Connector: USB-A-S-S-B-SM2-R by Samtec

The signals of the USB2.0 Typ-A connector are routed to the USB-Host port of the Trizeps module. The +5V supply to the USB-port are short-circuit protected and current-limited (0.75A-1.25A) by a power-switch.

J500, J503: Ethernet connector

The Ethernet connector uses the 10/100Mbit Ethernet-interface of the Trizeps module.

Three different POE (Power-Over-Ethernet) options are available:

1. No POE.
2. IEEE 802.3af compatible with max. 12W output to the panel and its peripherals.
3. A simplified version, where +12V..24V is applied to pins 7+8 and Gnd to pins 4+5 of the RJ45 connector.

On standard a RJ45 connector is used.

Optionally a PCB terminal block for easy push-in spring connection is mountable. Note that the PCB terminal block uses reverse pin-numbering compared to RJ45:

Pin	Signal
1	NC4 (+12..24V for simplified POE)
2	NC3 (+12..24V for simplified POE)
3	RX-
4	NC2 (Gnd for simplified POE)
5	NC1 (Gnd for simplified POE)
6	RX+
7	TX-
8	TX+

J503: PCB terminal block connector: 1771088 by Phoenix

D500: DUO LED (Link and Activity)

The LED next to the ethernet connector shows the status of the ethernet-connection:

- red - link-speed
- yellow - link-activity

J503: μ SD-Card connector

This μ SD-Card slot is powered by 3.3V.

Its signals are connected to the first SD/SDIO port of the Trizeps module.

It may be used to extend the storage-memory of the panel with a Micro-SD card.

3. Internal Connectors

J303: iMod USB/I2C connector

The iMod USB/I2C connector is a standard connector defined by Keith&Koep to allow customers to easily add functions to a baseboard.

Keith&Koep offers different extension boards ranging from a simple breakout board or an additional USB-type A connector to current-, voltage-, TOF-, NFC- sensors or IO-expander boards.

Customers may design their own peripherals which can be connected through a 10pol FFC cable.

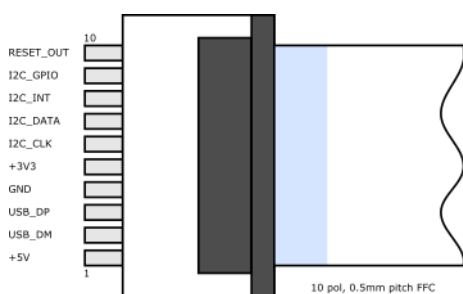

i.e.:
I2C-Sensors,
IO-Expanders,
USB-Port.

Pin	Signal	Function
1	+5V	Power
2	USB_DM	USB D- signal
3	USB_DP	USB D+ signal
4	GND	Power
5	+3V3	Power
6	I2C_CLK	I2C Clock signal
7	I2C_DATA	I2C Data signal
8	GPIO_00	GPIO; Mainly used as interrupt input pin by attached boards.
9	GPIO_AUX	GPIO; Mainly used as output.
10	\RESET_OUT	Reset output of the Trizeps module: Low during reset and suspend. High when running.

Connector: 687110149022 by Wuerth

The USB-OTG port of the Trizeps module is used by this connector.

This interface may be used as USB-Slave, USB-Host or real USB-OTG port. Actual function depends on Trizeps module and operating system.

Note that the USB-OTG port is also connected to the Micro-USB connector J501.

Only one of both connectors can be used at the same time!

The +5V power-supply-pin is not over-current protected.

J302: iMod UART connector

The iMod UART connector is a standard connector defined by Keith&Koep to allow customers to easily add functions to a baseboard.

Keith&Koep offers different extension boards ranging from a simple breakout board to RS232/RS485/RS422 transceiver boards.

Customers may design their own peripherals which can be connected through a 10pol FFC cable.

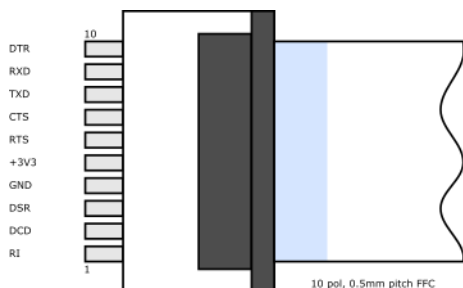

i.e.:
UART,
RS232,RS485
GPS, Modem,
GPIOs, ...

Pin	Signal	Function
1	UART1_RI	RI input
2	UART1_DCD	DCD input
3	UART1_DSR	DSR input
4	GND	Power
5	+3V3	Power
6	UART1_RTS	RTS output
7	UART1_CTS	CTS input
8	UART1_TXD	TXD output
9	UART1_RXD	RXD input
10	UART1_DTR	DTR output

Connector: 687110149022 by Wuerth

This connector uses UART1 (COM1:) of the Trizeps-module.

Besides using it as normal serial-port, it can additional be configured to give debug-output of the operating system or to enter the bootloader of the Trizeps on startup.

Most signal pins of a Trizeps can be configured as GPIOs. Some or even all UART-pins of this connector could be used as GPIOs.

J217: iMod Button/I2C or UART connector

The iMod connectors are standard connectors defined by Keith&Koep to allow customers to easily add functions to a baseboard.

There are two mounting options for J217:

a) iMod Button/I2C

The connector got 3 GPIOs for buttons and an I2C-interface for sensors etc.

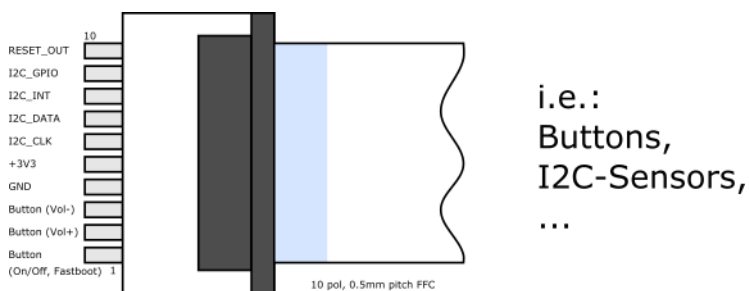

Pin	Signal	Function
1	FASTBOOT	On/Off, Fastboot, ... (OS-specific)
2	SP113	Generic Button, i.e. Volume+
3	SP117	Generic Button, i.e. Volume- (opt. RESET_IN of Trizeps module)
4	GND	Power
5	+3V3	Power
6	I2C_CLK	I2C Clock signal
7	I2C_DATA	I2C Data signal
8	SP119	GPIO; Mainly used as interrupt input pin by attached boards.
9	SP112	GPIO; Mainly used as output.
10	\RESET_OUT	Reset output of the Trizeps module: Low during reset and suspend. High when running.

Connector: 687110149022 by Wuerth

b) iMod UART

This connector adds one additional UART which can be connected to an RS232/RS485 extension board.

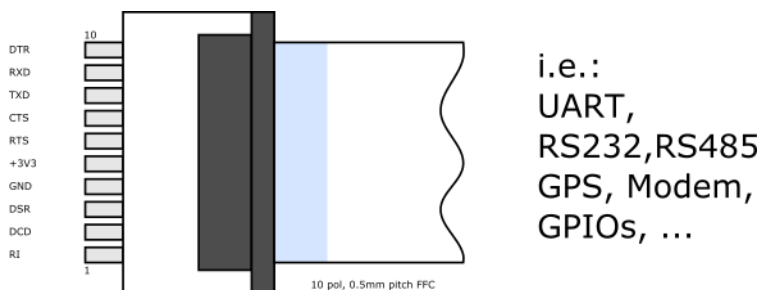

Pin	Signal	Function
1	FASTBOOT	On/Off, Fastboot, ... (OS-specific)
2	SP113	Generic Button, i.e. Volume+
3	SP117	Generic Button, i.e. Volume- (opt. RESET_IN of Trizeps module)
4	GND	Power
5	+3V3	Power
6	UART2_RTS	RTS output
7	UART2_CTS	CTS input
8	UART2_TXD	TXD output
9	UART2_RXD	RXD input
10	\RESET_OUT	Reset output of the Trizeps module: Low during reset and suspend. High when running.

Connector: 687110149022 by Wuerth

This connector uses UART2 (COM2:) of the Trizeps-module.

Note that unlike the iMod UART connector J302, only the TXD, RXD, RTS and CTS signals of the UART-interface are available. The GPIO-pins used for the buttons stay the same like on the iMod Button/I2C mounting option.

J305: iMod CAN connector

The iMod CAN connector is a standard connector defined by Keith&Koep to allow customers to easily add a CAN transceiver & connector to the baseboard.

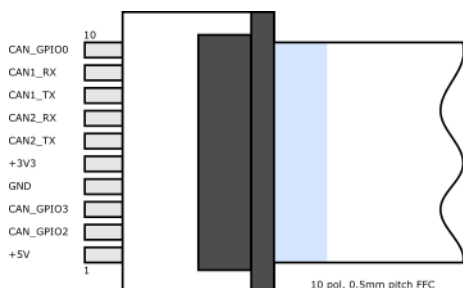

2x CAN ports.
CAN-Transceiver
isolated/non-isolated,
GPIOs

Pin	Signal	Function
1	+5V	Power
2	CAN_GPIO2	Generic GPIO
3	CAN_GPIO3	Generic GPIO
4	GND	Power
5	+3V3	Power
6	CAN2_TX	Single ended TX output of CAN port 2
7	CAN2_RX	Single ended RX input of CAN port 2
8	CAN1_TX	Single ended TX output of CAN port 1
9	CAN1_RX	Single ended RX input of CAN port 1
10	CAN_GPIO0	Generic GPIO

Connector: 687110149022 by Wuerth

The CAN_TX and CAN_RX are single-ended 3V3-level signals.
A CAN-transceiver is needed to convert these to a differential CAN signal.

CAN_GPIO signals may be used for auxiliary functions, i.e. enabling CAN-termination.

J200: Trizeps VII SODIMM connector

This SODIMM200 Trizeps connector can be populated with different Trizeps modules.
Although earlier and future Trizeps products will fit too, currently only Trizeps VII modules are shipped with i-PAN T10.

Functionality of the whole i-PAN T10 varies depending on which Trizeps module is inserted!
(i.e. processing speed, RAM, Wifi and Bluetooth, audio ...)

For the actual pinning of this connector refer to the Trizeps VII datasheet.

J201: Trizeps VII High Speed connector

For the actual pinning refer to the Trizeps VII datasheet.

This connector carries the MIPI camera signals which are routed to the Raspberry Pi compatible camera connector J218 and the LVDS display connector J301.

J301: Display connector

The i-PAN T10 baseboard is qualified to connect with a 10.1 inch display:

- 10.1" TFT Display; IPS technology
- 1280x800 resolution.
- 420cd/qm
- 3mm glas
- projected capacitive touch.

Please contact Keith&Koep if you require another display-specification.

J300: Touch connector

See "J301: Display connector".

J218: Raspberry Pi compatible camera connector

The iPAN-T10 got a Raspberry Pi compatible connector to attach 2 channel MIPI cameras through a flex-cable.

Pin	Signal
1	GND
2	CSI1_DAT0_N
3	CSI1_DAT0_P
4	GND
5	CSI1_DAT1_N
6	CSI1_DAT1_P
7	GND
8	CSI1_CLK_N
9	CSI1_CLK_P
10	GND
11	CAM_PWDN
12	CAM_GPIO / CAM_CLK
13	I2C1_SCL
14	I2C1_SDA
15	+3V3

Connector: 52271-1579 by Molex

Soldering pads

Pad	Signal	Function
J203	FASTBOOT	On/Off, Fastboot, ... (OS-specific)
J204	GND	Power
J205	SPEAKER_P	2,5W Class-D Audio-Amp
J206	SPEAKER_N	2,5W Class-D Audio-Amp
J207	SPI1_SS0	*1)
J208	SPI1_SCLK	*1)
J209	SPI1_MOSI	*1)
J210	SPI1_MISO	*1)
J211	+3V3	Power
J212	HEADPHONE_GND	Headphone Ground
J213	HEADPHONE_L	Stereo Headphone Left
J214	HEADPHONE_R	Stereo Headphone Right
J215	MIC_OUT	Microphone Input
J219	MIC_GND	Microphone Ground

*1) Pin function depends on the Trizeps module and may require a special version to use SPI-functionality. With a mounting option of the Trizeps VII module it is possible to route an UART RXD/TXD signal to these pins.

Headphone signals are routed to a 2,5W Class-D Audio-Amp, which outputs to the SPEAKER-pins. It is possible to enable and disable the Speaker-Amp, but it is not possible to output different sounds to headphone and speaker at the same time.

The same headphone and microphone signals are used by "J306: Headset 3.5mm Audio Jack (CTIA)".

4. Miscellaneous

Batt200: Battery connector

The battery (CR1632) supplies the Realtime clock.

S200: Fastboot switch

The Fastboot switch is connected to the Fasboot-signal, which is used by different connectors and a solder-pad of the i-PAN T10. Its function depends on the operating system. I.e. it may act as suspend/resume switch in WEC7 or Fasboot switch for Android.

Realtime Clock

The i-PAN T10 got a Realtime-Clock which keeps time and date while the device is powered off. It is supplied by Batt200 when disconnected from the power-supply.

I2C-EEPROM

An optional I2C-EEPROM on the i-PAN T10 can be used to store data.

For example it can be used to store production-data, a serial-number or license-keys independent of the Trizeps main-storage.

Power-Fail & Voltage Supervisor

The i-PAN T10 got a circuit to detect when the input-voltage drops below a specific level.

(The level is set through resistors and can be adjusted to customer needs.)

If that happens a signal to the Trizeps powerfail GPIO (SODIMM-Pin 79) is issued and the application software is able to shut down or store process-data. In comparison to the i-PAN XT-Pro 10 the i-PAN T10 has got no UPS-feature (uninterruptable power supply), so that the time between power fail and power off is greatly dependent on the external power-source.

The input voltage may be measured by ADC-input 2 of the Trizeps module (SODIMM-Pin 4).

5. Electrical Pin-Information

PI: Power Input
 PO: Power Output
 CO: Charger Output

AI: Analog Input
 AO: Analog Output

DI: Digital Input
 DO: Digital Output
 DIO: Digital Input/Output

DIFI: Differential Input
 DIFO: Differential Output
 DIFIO: Differential Input/Output

PD: Pull-Down (PDp: Pull-Down, Pull-behavior can be changed by software)
 PU: Pull-Up (PUp: Pull-Up, Pull-behavior can be changed by software)

SPIN: SODIMM-Pin number. In the tables listed below, typical a transceiver-chip is in between the Trizeps-module and the connector!

J400: Power Connector

PIN	Name	Type	Voltage	Connected To
J400-1	VIN	PI	9 ... 24V	
J400-2	GND			

J302: iMod UART Connector

PIN	Name	Type	Voltage	Connected To
J302-1	UART1_RI	DI	+3V3	SPIN37
J302-2	UART1_DCD	DI	+3V3	SPIN31
J302-3	UART1_DSR	DI	+3V3	SPIN29
J302-4	GND			
J302-5	+3V3	PO		
J302-6	UART1_RTS	DO	+3V3	SPIN27
J302-7	UART1_CTS	DI	+3V3	SPIN25
J302-8	UART1_TXD	DO	+3V3	SPIN35
J302-9	UART1_RXD	DI	+3V3	SPIN33
J302-10	UART1_DTR	DO	+3V3	SPIN23

J303: iMod USB/I2C Connector

PIN	Name	Type	Voltage	Connected To
J303-1	+5V	PO		
J303-2	USB_HOST3_DM	DIO	+3V3	SPIN141
J303-3	USB_HOST3_DP	DIO	+3V3	SPIN139
J303-4	GND			
J303-5	+3V3	PO		
J303-6	I2C_CLK	DO	+3V3	SPIN196
J303-7	I2C_DATA	DIO	+3V3	SPIN194
J303-8	GPIO_00	DIO	+3V3	SPIN43
J303-9	GPIO_AUX	DIO	+3V3	SPIN98
J303-10	RESET_OUT_N	DO	+3V3	SPIN87

J305: iMod CAN connector

PIN	Name	Type	Voltage	Connected To
J305-1	+5V	PO		
J305-2	CAN_GPIO2	DIO	+3V3	SPIN126
J305-3	CAN_GPIO3	DIO	+3V3	SPIN128
J305-4	GND			
J305-5	+3V3	PO		
J305-6	CAN2_TX	DO	+3V3	SPIN103
J305-7	CAN2_RX	DI	+3V3	SPIN101
J305-8	CAN1_TX	DO	+3V3	SPIN99
J305-9	CAN1_RX	DI	+3V3	SPIN97
J305-10	CAN_GPIO0	DIO	+3V3	SPIN132

J217: iMod Button/I2C connector

PIN	Name	Type	Voltage	Connected To
J217-1	FASTBOOT	DIO	+3V3	SPIN122 SPIN43 (opt.)
J217-2	SP113	DIO	+3V3	SPIN113
J217-3	SP117 \RESET_IN (opt.)	DIO DI	+3V3 +3V3	SPIN117 SPIN26
J217-4	GND			
J217-5	+3V3	PO		
J217-6	I2C_CLK UART2_RTS (opt.)	DO DO	+3V3 +3V3	SPIN196 SPIN34
J217-7	I2C_DATA UART2_CTS (opt.)	DIO DI	+3V3 +3V3	SPIN194 SPIN32
J217-8	SP119 UART2_TXD (opt.)	DIO DO	+3V3 +3V3	SPIN119 SPIN38
J217-9	SP112 UART2_RXD (opt.)	DIO DI	+3V3 +3V3	SPIN112 SPIN36
J217-10	\RESET_OUT	DO	+3V3	SPIN87

J218: Raspberry Pi compatible camera connector

PIN	Name	Type	Voltage	Connected To
J502-1	GND			
J502-2	CSI_DAT0_N	DIFI	MIPI	J216.61
J502-3	CSI_DAT0_P	DIFI	MIPI	J216.63
J502-4	GND			
J502-5	CSI_DAT1_N	DIFI	MIPI	J216.66
J502-6	CSI_DAT1_P	DIFI	MIPI	J216.65
J502-7	GND			
J502-8	CSI_CLK_N	DIFO	MIPI	J216.62
J502-9	CSI_CLK_P	DIFO	MIPI	J216.64
J502-10	GND			
J502-11	CAM_PWDN	DO	+3V3	SPIN123
J502-12	CAM_GPIO	DIO	+3V3	SPIN125
	CAM_CLK (opt.)	DO	+3V3	SPIN88
J502-13	I2C1_CLK	DO	+3V3	SPIN94
J502-14	I2C1_DAT	DIO	+3V3	SPIN96
J502-15	+3V3	PO		

6. Specifications

6.1 Absolute Maximum Ratings

Absolute maximum ratings reflect conditions that the module may be exposed outside of the operating limits, without experiencing immediate functional failure. Functional operation is only expected during the conditions indicated under "Recommended Operating Conditions". Stresses beyond those listed under "Absolute Maximum Ratings" may cause permanent damage to the module. Exposure to absolute-maximum rated conditions for extended periods may affect device reliability.

	Pin	Min	Max	Unit
Supply Voltage	+Vin	0	36	V
Storage Temperature	T _{Storage}	-30	+80	°C

6.2 Recommended Operating Conditions

	Pin	Min	Typ	Max	Unit
Supply Voltage	+Vin	8	12/24	32	V
Supply current @12V with Trizeps7 DualLite WB and 10" display. Note that the supply current heavily depends on the used Trizeps module and application use-case. A min. 12V 1A power- supply is recommended.	Linux idle Linux using		360 470		mA
Operating temperature		-20	25	70	°C

Note: Operating conditions will differ depending on used Trizeps module and display.

6.3 Mechanical Specification

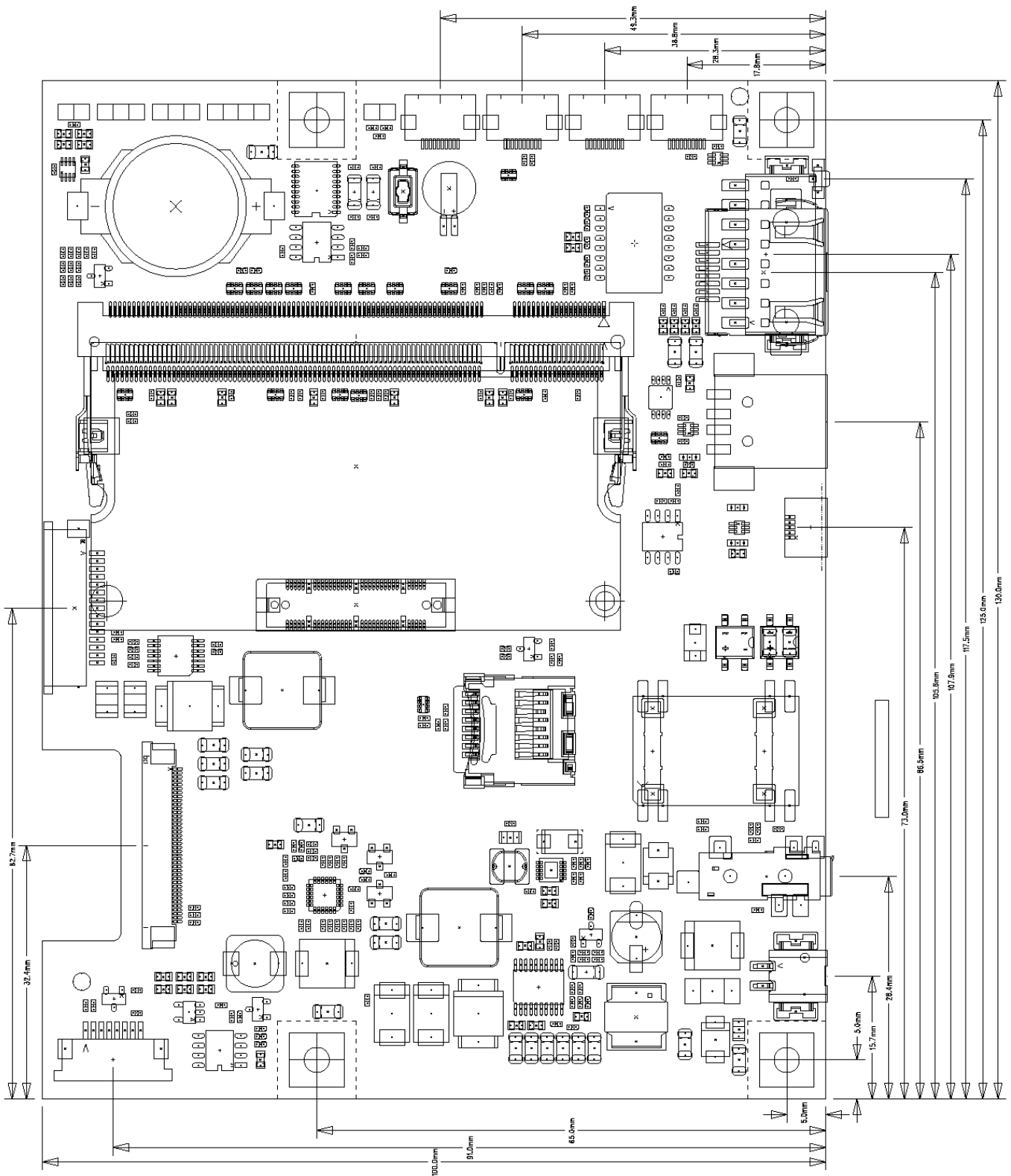

Figure 3-3-1: Top-View on i-PAN T10 Baseboard V1R2

Dimensions: i-PAN T10 Baseboard: 130.0 x 100.0 x 17.0 mm (W x H x D)

7. Ordercodes for i-PAN T10

49 100.CL: i-PAN T10 CoverLens LC (Low Cost), incl. 10.1 inch Touch-Display with cover lens, i-PAN T10 Baseboard LC (without Trizeps VII)

49 400.CL: i-PAN T10 CoverLens FF (Full Function), incl. 10.1 inch Touch-Display with cover lens, i-PAN T10 Baseboard FF (without Trizeps VII)

8. Important Notice

This datasheet might contain errors.
Product-specification may change without further notice.

If you need to rely on a feature or specification, please contact Keith&Koep GmbH before placing an order.

This product is sold in multiple configurations and housing options.
Customers must check whether their configuration fulfills legal rules and regulations incl. RED (Radio Equipment Directive), CE, FCC and others.
Certificates of the products are usually uploaded to the Keith&Koep support website:
<http://support.keith-koep.com/service/doku.php>

9. Document History

Rev.	Date	Author	Changes
0.9	13.04.2017	VB	Initial Version.
1.0	15.05.2017	SH	Complete rework.
1.1	21.07.2017	SH	Reduced VIN ratings.